

# Klixon | SB/ESB SERIES THERMAL PROTECTORS

WORLD CLASS  
PERFORMANCE

The SB/ESB Series thermal protector offers the reliability of a bimetal protector in a robust hermetic package. It is ideally suited to provide thermal and/or locked rotor protection in applications requiring unique processing or environmental challenges (AC/DC motors, compressors, transformers, etc.).

With an exceptional history of more than 90 years, Sensata Technologies is a leading supplier of sensors and switches.

**Features**

- Hermetically sealed
- Compact
- Opening temperature range of 60°C to 170°C in 5°C increments
- Snap action
- Copper or tin plated copper leads in a variety of lengths

**Benefits**

- Safe from penetration of fluids
- Ultimate corrosion protection
- No secondary insulation needed
- Can operate in high pressure environments
- Improves safety of end product

Sensata Technologies' miniature, glass encapsulated thermal protectors provide both thermal and current overload protection. The SB/ESB family of protectors combines Sensata's bimetal protection technology with a true glass to metal hermetic seal. This ultra-reliable combination can be used for such things as small AC fractional horsepower motors, DC motors, battery chargers, ballasts, NiCad battery packs, transformers and internal protection for compressors.

Sensata Technologies is an ISO and TS registered company providing world class quality products.

**Test House Approvals**

BEAB - EN60730-2-1, EN60730-2-2 Open Motors (BEAB-CRC 0004)  
IEC 730-2-4 Compressor Motors  
UL Files E37501 & E28135, UL Nos. 547 & 873  
UL IEC 730-2-2 Open Motors  
CSA File LR 20529, C22.2 Nos. 77 & 24

**Dimensional Drawing**

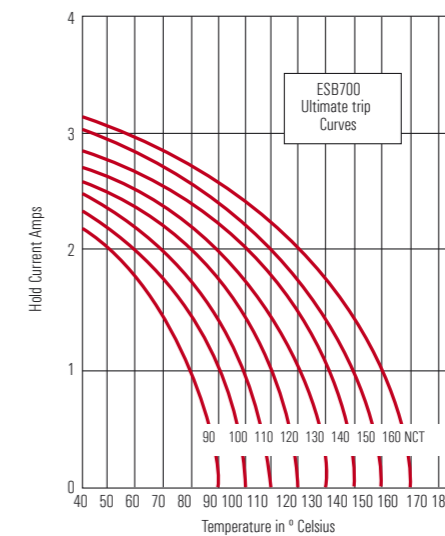
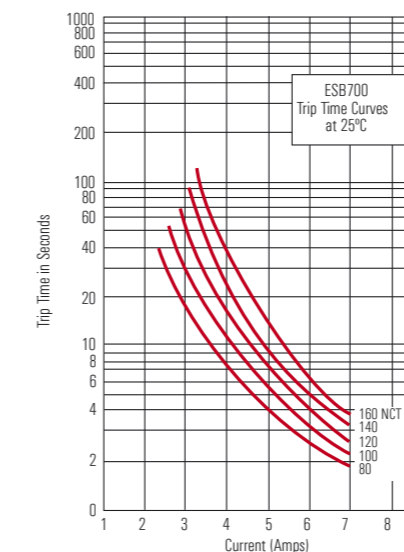
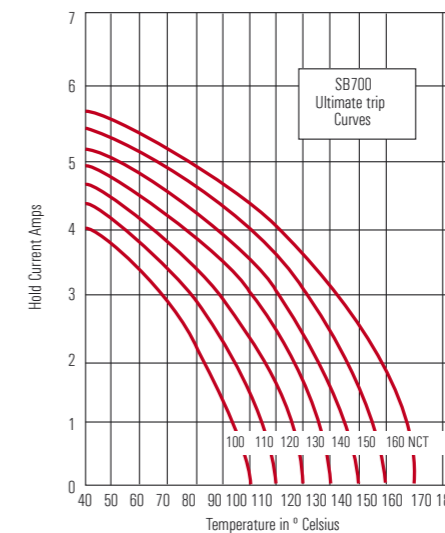
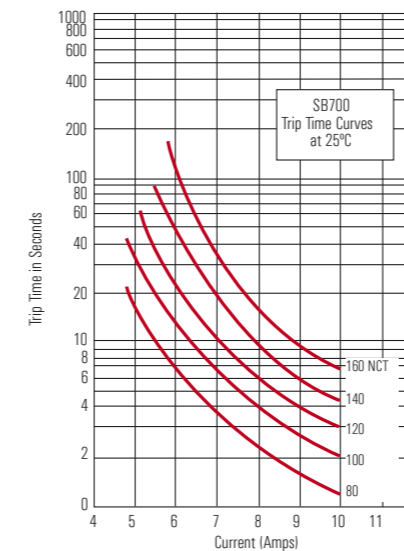
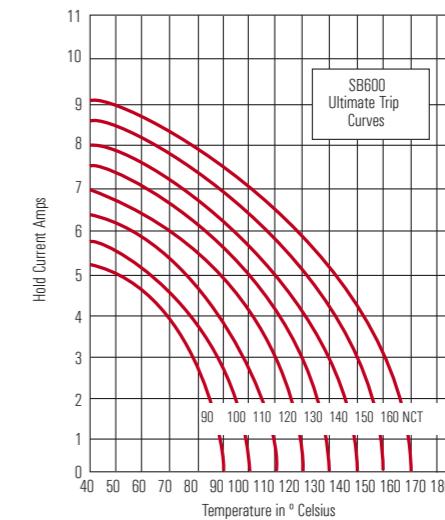
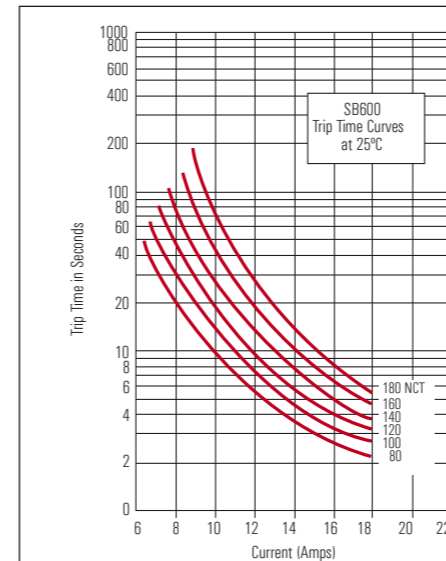
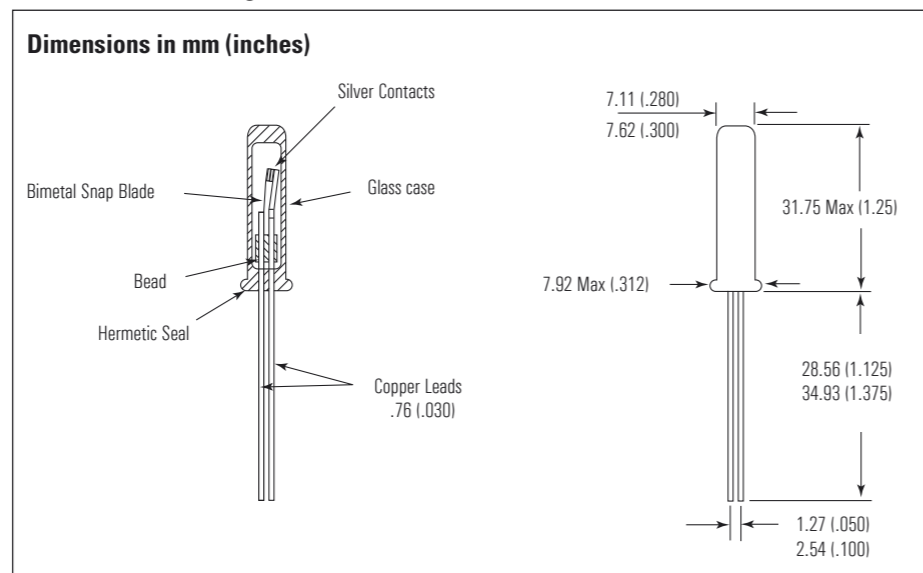

These curves are to be used only as a guide in selecting a protector for a particular application. Factors such as distance from the heat source and the method of mounting should be considered in selecting a protector. Final trip times are dependent upon terminal configuration and mounting in the application