



| GXC15 Series

350+ AMP 12-800 VDC

Introduction

Automatic-Trip, Over-Current Contactor with CAN-BUS Communication



Features

- Chassis level power terminals – No need for specially routed power cables, special bus bars, or special lugs.
- Rugged EPIC® seal rated to 175°C – Reduced risk of fire or meltdown in over current conditions. The same technology used for advanced aerospace programs.
- Hermetically sealed – Designed to meet: UL1604 for Class I & II, Div 2 and Class III for use in hazardous locations, IP67 for temporary water immersion for 30 min, IP69K for pressure washing, SAE J1171 - external ignition protection, and ISO8846 for protection against ignition around flammable gasses.
- High Efficiency Dual DC Coils – Very low 12 or 24 VDC continuous coil power with no EMI emissions or crosstalk on your system control power. Ideal for battery powered systems or where low power is needed.
- Built-in coil suppression for all DC coils – Saves you engineering time and parts cost to add external coil suppression.
- Stainless steel nuts and mounting inserts, for years of corrosion free service.
- Not position sensitive – can be mounted in any position for ease of installation.



SPECIFICATIONS

Specifications		Units	Data
Contact Arrangement		Form X	SPST-NO
Mechanical Life		Cycles	1,000,000
Contact Resistance¹	Max	mohms	0.4
	Typical	mohms	0.15 to 0.3
Operate Time²	Max	ms	20
	Typical	ms	13
Release Time, Max		ms	12
Insulation Resistance³		Mohms	100
Dielectric at Sea Level (Leakage < 1mA)		VRMS	2,200
Shock, 1/2 Sine, 11ms		G peak	20
Vibration, Sinusoidal (500-2000 Hz Peak)		G	15
Ambient Temp Range	Operating⁴	°C	-55 to +85
	Storage	°C	-70 to +150
Weight, Typical		Kg (Lb)	0.73 (1.6)
Environmental Seal	Exceeds IP67 & IP69K		
Salt Fog	MIL-STD-810		

Coil Ratings at 25°C (25°C, Currents & Power At Nominal V)

Coil P/N Designation	B	C
Coil Voltage (Nominal)	12 VDC	24 VDC
Coil Voltage (Max)	16 V	32 V
Coil Voltage (Min) ^{5,7}	9 V	17 V
Inrush Current (Max) ^{5,6}	3.9 A	1.6 A
Hold Current after Inrush (Max) ⁶	0.23 A	0.097 A
Coil Hold Power (Max) ⁶	2.8 W	2.3 W
Coil Back EMF ⁹	0 V	
Transients on Power Pins (2, 7)	+50 V, 13 ms	
Vin Power Pins (2, 7) Reverse Polarity (Max)	-80 V	



POWER SWITCHING AND CURRENT CARRY RATINGS

DC POWER SWITCHING CYCLES⁸

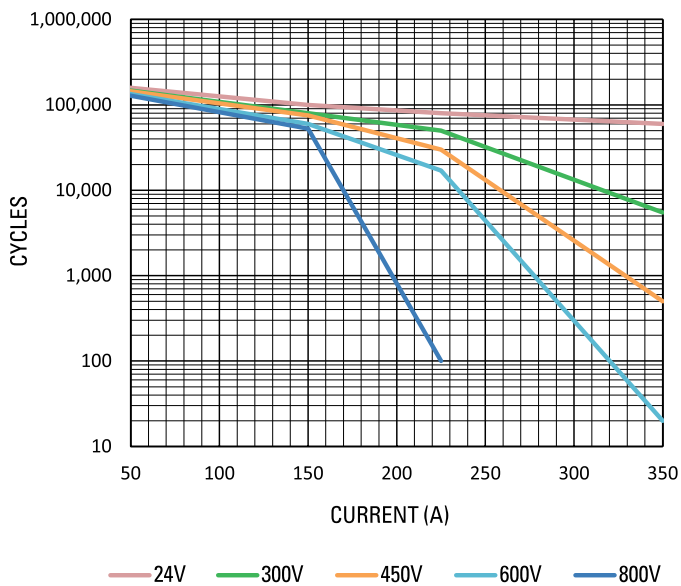

CURRENT CARRY vs TEMPERATURE

with 4/0 AWG (120 mm²) conductor

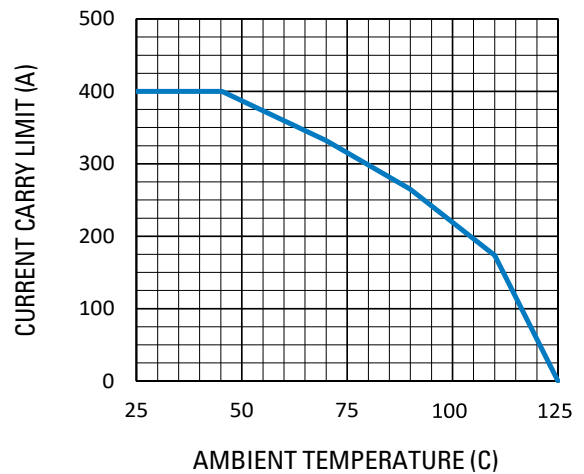

SOFTWARE SETTINGS PARAMETERS

Parameter	Units	Data
Current Trip Setting Range	A	±(20-600)
Current Sense Accuracy		±7%
Over Current Response Time	ms	2ms + release time



DIMENSIONS

Control and Communication

To enable internal 120ohm CAN termination:
Jumper Pin1 and Pin5.
See Notes & Definitions 10.

Mounting

M6 Bolts

Case Material

DuPont Zytel FR50
(25% Glass Filled Nylon)

Power Connection

Zinc Plated M12x1.75 Bolt
Stainless M12x1.75 Flanged Nut
Torque 23-34Nm [200-300in-lb]

Mating Connector

Gigavac offers the required mating connector as an assembled unit (0857-9/10) or as a component package, see Accessories.
Deutsch Connector Housing P/N: DT06-08SA
Solid Contact Socket P/N: 0462-201-16141
Wedge Lock P/N: W8S
Sealing Plug P/N: 114017
Crimp Tool P/N: HDT-48-00

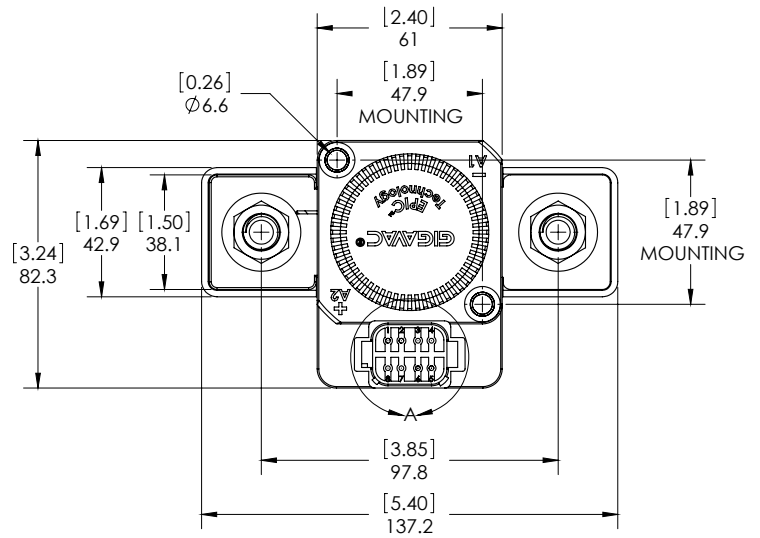
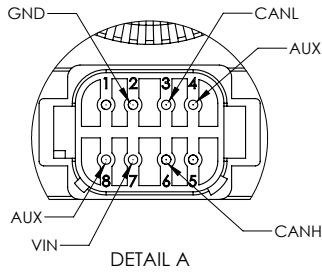

Power Contacts

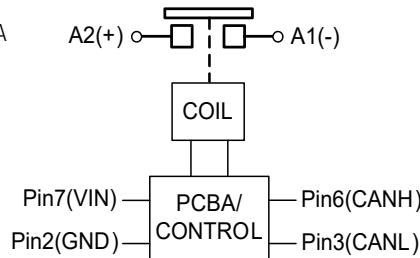

CANH and CANL comply with CAN-BUS specification

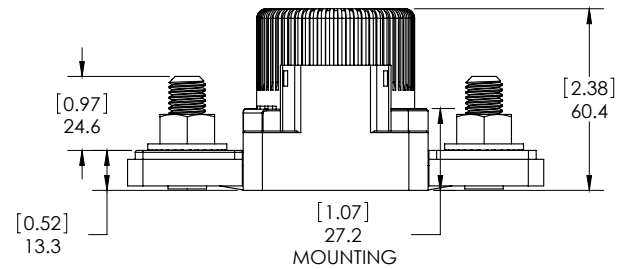

ORDERING OPTIONS

Example : GXC15BEXV

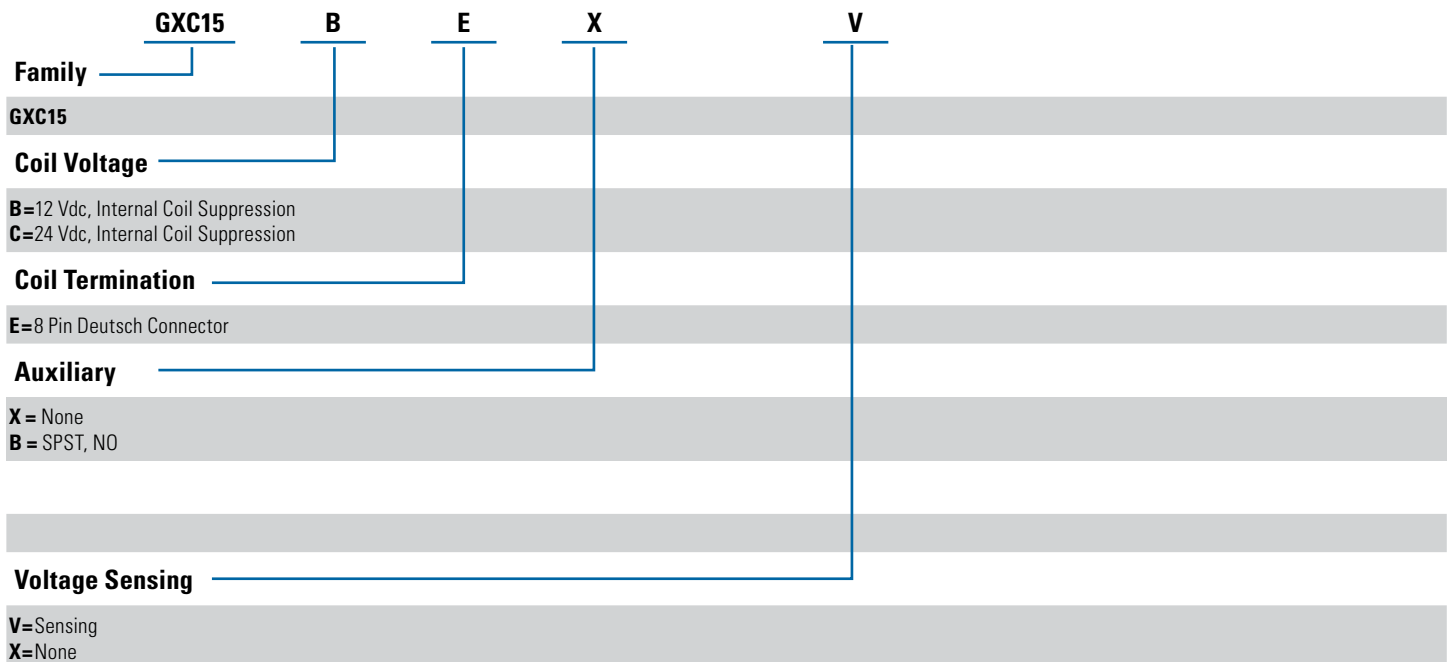



FOOTNOTES

1. Contact resistance measured at currents higher than 100A.
2. Operation time is measured at 25°C and includes maximum 7ms bounce.
3. Insulation resistance is 50 Mohms after life.
4. Contactor can operate up to 125°C in special cases - contact GIGAVAC for details.
5. Contactor has two coils. Both are used for pick-up, and then in approximately 75 milliseconds, one coil is electronically removed from the coil drive circuit. The remaining coil supplies low continuous hold power sufficient for the contactor to meet all of its specified performance specifications. This provides low coil power without PWM electronics that can cause EMI emissions and/or cross-talk on control power.
6. Contactor is operated by a coil that changes resistance with temperature. Since inrush current, hold current and coil hold power are specified at nominal voltage, they will be lower than indicated at temperatures above 25°C and higher than indicated at temperatures below 25°C. Similarly, pick-up and drop-out voltages will be higher than indicated at temperatures above 25°C and lower than indicated at temperatures below 25°C.
7. For pick-up testing of contactors with dual coils, the voltage can not be ramped up slowly, but must be applied instantly to at least the maximum pick-up voltage. Otherwise, the contactor will not pick-up.
8. Limit make current to 600A to avoid contact welding. For AC power switching cycles, contact factory.
9. Coils are switched internally with a FET, so no fly-back/suppression voltage is seen at the coil inputs.
10. Control and Communication
Protocol: J1939
Features:
 - Read: device ID, firmware version, current, temperature, contactor cycle-log and optional contact-volts sensing.
 - Read/Write: power supply under-voltage-shutoff, contactor (open/close), trip points, trip delays, power up default (open/close).
 - Contact GIGAVAC for CAN-BUS communication protocol details.



TECHNICAL NOTES

1. Power switching lifecycles are based on current flow from A1(+) to A2(-). For best breaking performance, the contactor should be installed so that current flows from A1(+) to A2(-). There are cases where the contactor will interrupt power in the opposite direction but please contact Sensata to confirm suitability. Direction of current flow is not relevant during make or when flowing on closed contacts. For bi-directional contactors, please contact Sensata.
2. Applications with capacitors will require a pre-charge circuit.
3. Electrical life rating is based on resistive load with 27µH maximum inductance in circuit. Because your application may be different, we suggest you test the contactor in your circuit to verify life is as required.
4. End of life is defined as when the dielectric, insulation resistance or contact resistance exceeds the specifications listed.

Sensata Technologies, Inc. ("Sensata") data sheets are solely intended to assist designers ("Buyers") who are developing systems that incorporate Sensata products (also referred to herein as "components"). Buyer understands and agrees that Buyer remains responsible for using its independent analysis, evaluation and judgment in designing Buyer's systems and products. Sensata data sheets have been created using standard laboratory conditions and engineering practices. Sensata has not conducted any testing other than that specifically described in the published documentation for a particular data sheet. Sensata may make corrections, enhancements, improvements and other changes to its data sheets or components without notice.

Buyers are authorized to use Sensata data sheets with the Sensata component(s) identified in each particular data sheet. HOWEVER, NO OTHER LICENSE, EXPRESS OR IMPLIED, BY ESTOPPEL OR OTHERWISE TO ANY OTHER SENSATA INTELLECTUAL PROPERTY RIGHT, AND NO LICENSE TO ANY THIRD PARTY TECHNOLOGY OR INTELLECTUAL PROPERTY RIGHT, IS GRANTED HEREIN. SENSATA DATA SHEETS ARE PROVIDED "AS IS". SENSATA MAKES NO WARRANTIES OR REPRESENTATIONS WITH REGARD TO THE DATA SHEETS OR USE OF THE DATA SHEETS, EXPRESS, IMPLIED OR STATUTORY, INCLUDING ACCURACY OR COMPLETENESS. SENSATA DISCLAIMS ANY WARRANTY OF TITLE AND ANY IMPLIED WARRANTIES OF MERCHANTABILITY, FITNESS FOR A PARTICULAR PURPOSE, QUIET ENJOYMENT, QUIET POSSESSION, AND NON-INFRINGEMENT OF ANY THIRD PARTY INTELLECTUAL PROPERTY RIGHTS WITH REGARD TO SENSATA DATA SHEETS OR USE THEREOF.

All products are sold subject to Sensata's terms and conditions of sale supplied at www.sensata.com SENSATA ASSUMES NO LIABILITY FOR APPLICATIONS ASSISTANCE OR THE DESIGN OF BUYERS' PRODUCTS. BUYER ACKNOWLEDGES AND AGREES THAT IT IS SOLELY RESPONSIBLE FOR COMPLIANCE WITH ALL LEGAL, REGULATORY AND SAFETY-RELATED REQUIREMENTS CONCERNING ITS PRODUCTS, AND ANY USE OF SENSATA COMPONENTS IN ITS APPLICATIONS, NOTWITHSTANDING ANY APPLICATIONS-RELATED INFORMATION OR SUPPORT THAT MAY BE PROVIDED BY SENSATA.

Mailing Address: Sensata Technologies, Inc., 529 Pleasant Street, Attleboro, MA 02703, USA.

Americas

Sensata GIGAVAC
Contactor Center of Excellence
6382 Rose Lane
Carpinteria, CA 93013
USA
Tel: +1 (805) 684 8401
Email: gigavac@sensata.com
Sensata Global Headquarters
Sensata Technologies
529 Pleasant Street
Attleboro, MA 02703
USA

Europe, Middle East & Africa

Sensata Technologies Holland B.V.
Jan Tinbergenstraat 80
7559 SP Hengelo
The Netherlands
Tel: +31743578000
Email: gigavac-info-eu@list.sensata.com

CONTACT US

Asia Pacific

China
Sensata Technologies China Co., Ltd.
BM Intercontinental Business Center
30th Floor
100 Yu Tong Road
Shanghai 200070
People's Republic of China
Tel: +8621 2306 1500
Email: contactorasia@list.sensata.com
Japan
Sensata Technologies Japan Ltd.
Shin Yokohama Square Bldg. 7F
2-3-12 Shin-yokohama
Kohoku-ku, Yokohama-shi,
Kanagawa 222-0033
Tel: +81 45 277 7001
Email: contactorasia@list.sensata.com