

## FEATURES

- Chassis level power terminals – No need for specially routed power cables, special bus bars, or special lugs.
- Rugged **EPIC®** seal rated to 175°C – Reduced risk of fire or meltdown in over current conditions. The same technology used for advanced aerospace programs.
- Hermetically sealed – Designed to meet: UL1604 for Class I & II, Div 2 and Class III for use in hazardous locations, IP67 for temporary water immersion for 30 min, IP69K for pressure washing, SAE J1171 - external ignition protection, and ISO8846 for protection against ignition around flammable gasses.
- High Efficiency Dual DC Coils – Very low 12 or 24 VDC continuous coil power with no EMI emissions or cross-talk on your system control power. Ideal for battery powered systems or where low power is needed.
- Built-in coil suppression for all DC coils – Saves you engineering time and parts cost to add external coil suppression.
- Stainless steel nuts and mounting inserts, for years of corrosion free service.
- Not position sensitive – can be mounted in any position for ease of installation.

### PRODUCT SPECIFICATIONS

Specifications	Units	Data
<b>Contact Arrangement</b>		
Main	Form X	SPST-NO
Auxiliary (2A, 24VDC) <sup>1</sup>	Form A or B	SPST-NO or SPST-NC
<b>Mechanical Life</b>		
	Cycles	1,000,000
<b>Contact Resistance<sup>2</sup></b>		
Max	mohms	1.5
Typical	mohms	0.4
<b>Operate Time<sup>3</sup></b>		
Max	ms	20
Typical	ms	13
<b>Release Time, Max</b>		
	ms	12
<b>Insulation Resistance<sup>4</sup></b>		
	Mohms	100
<b>Dielectric At Sea Level (Leakage &lt; 1mA)</b>		
	VRMS	2,200
<b>Shock, 1/2 Sine, 11ms</b>		
	G peak	20
<b>Vibration, Sinusoidal (500-2000 Hz Peak)</b>		
	G	15
<b>Ambient Temp Range</b>		
Operating <sup>5</sup>	°C	-55 to +85
Storage	°C	-70 to +150
<b>Weight, Typical</b>		
	Kg (Lb)	0.73 (1.6)
<b>Environmental Seal</b>		
		Exceeds IP67 & IP69K
<b>Salt Fog</b>		
		MIL-STD-810

### POWER SWITCHING AND CURRENT CARRY RATINGS

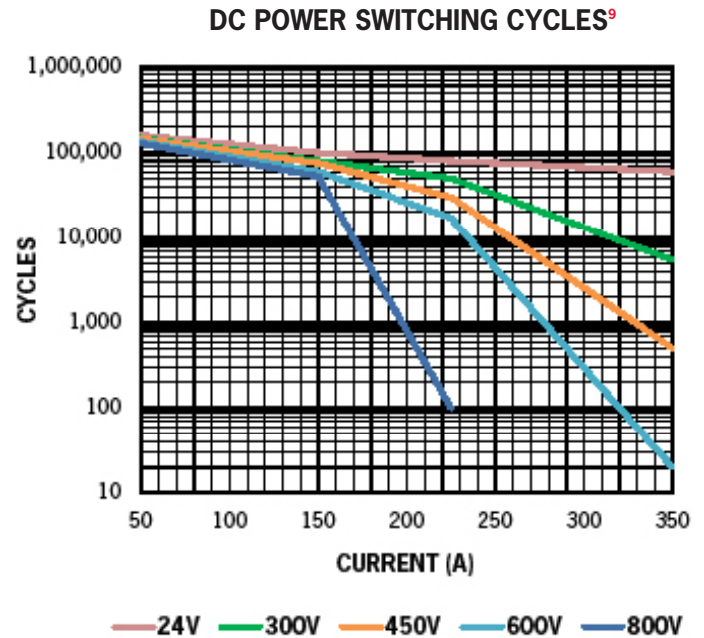

### COIL RATINGS at 25°C

Coil P/N Designation	B	C
Coil Voltage, Nominal	12 VDC	24 VDC
Coil Voltage, Max	16 V	32 V
Pick-Up Voltage, Max <sup>6, 8</sup>	8 V	16 V
Drop-Out Voltage	0.5 to 4 V	2 to 7.5 V
Pick-Up Current, Max (75 ms) <sup>6, 7</sup>	3.9 A	1.6 A
Coil Current <sup>7</sup>	0.23 A	0.097 A
Coil Power <sup>7</sup>	2.8 W	2.3 W
Internal Coil Suppression		
Coil Back EMF	55 V	
Transients, Max (13 ms)	±50 V	
Reverse Polarity	16 V	32 V

### CURRENT CARRY vs TEMPERATURE with 4/0 AWG conductor

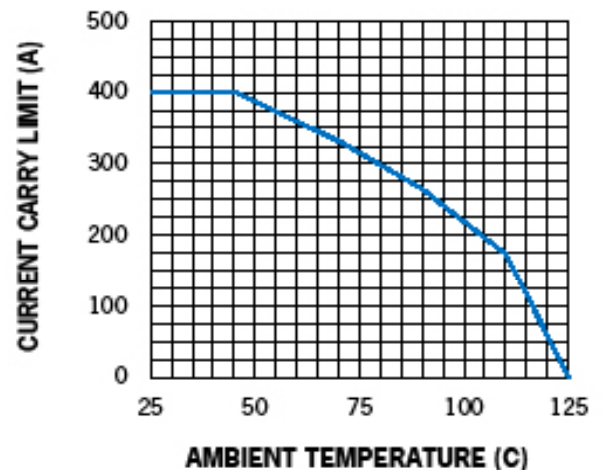



**Authorized Sales Rep.**  
 59 Rue Emile Deschanel, 92400  
 Courbevoie, France  
[contact@jbcontrols.com](mailto:contact@jbcontrols.com)  
 Tel: + 33 (0)1 46 91 93 30  
[www.jbcontrols.com](http://www.jbcontrols.com) - [www.jbc-aero.com](http://www.jbc-aero.com)

**350+ Amp 12-800 Vdc**  
**EPIC® Hermetic Sealed DC Contactor**

**GXSB15**

## DIMENSIONS

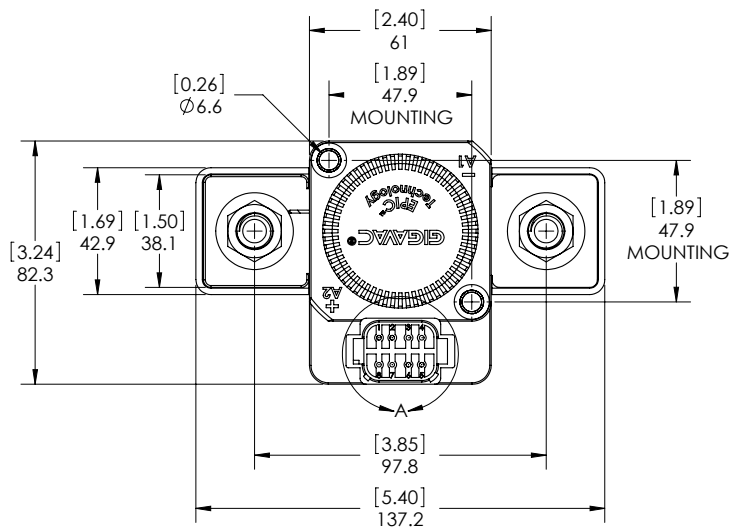
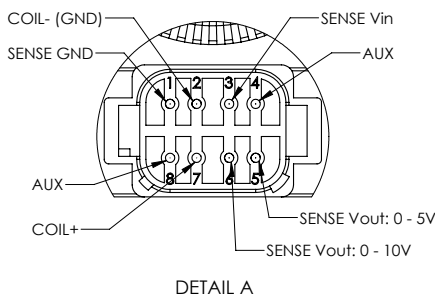
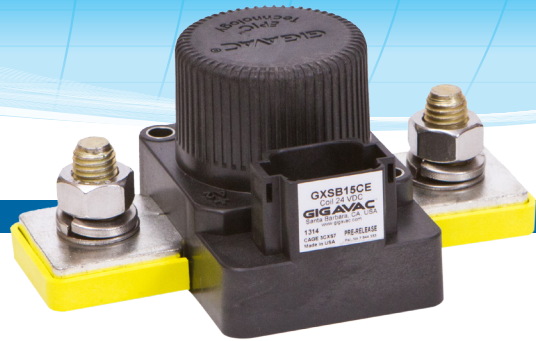

### Mounting

M6 Bolts

### Case Material

DuPont Zytel FR50  
 (25% Glass Filled Nylon)

### Power Connection

Zinc Plated M12x1.75 Bolt  
 Stainless M12x1.75 Flanged Nut

Torque 23-34Nm [200-300in-lb]

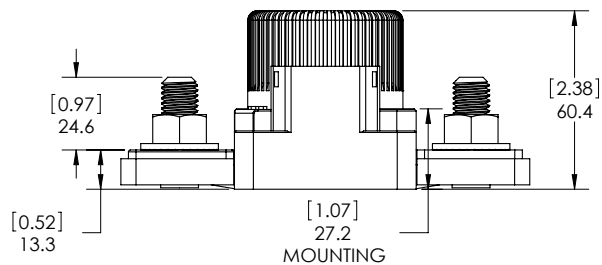

### Mating Connector

Gigavac offers the required mating connector as an assembled unit ([0857-1/2](#)) or as a component package, see Accessories.

Deutsch Connector Housing P/N: DT06-08SA  
 Solid Contact Socket P/N: 0462-201-16141  
 Wedge Lock P/N: W8S  
 Sealing Plug P/N: 114017  
 Crimp Tool P/N: HDT-48-00

### Power Contacts

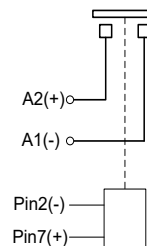

### Auxiliary contacts (optional)

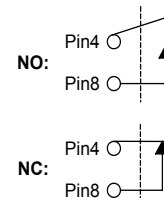

## PART NUMBER SYSTEM

350+ Amp 12-800 Vdc  
EPIC® Hermetic Sealed DC Contactor

**GXSB15**

GXSB15	B	E	B
Coil Voltage	B = 12 Vdc, Internal Coil Suppression		
	C = 24 Vdc, Internal Coil Suppression		
Coil Termination		E = 8 Pin Deutsch Connector	
Auxiliary Contact			Blank = None
			B = SPST, Normally Open
			C = SPST, Normally Closed

### Notes & Definitions:

- 1 Auxillary contact rating is 2A, 24Vdc Resistive load, 100,000 cycles. Minimum current is 0.1mA, 5V. The auxiliary contact is mechanically linked to the main power contacts.
- 2 Contact resistance measured at currents higher than 100A.
- 3 Operation time is measured at 25°C and includes maximum 7ms bounce.
- 4 Insulation resistance is 50 Mohms after life.
- 5 Contactor can operate up to 125°C in special cases - contact GIGAVAC for details.
- 6 Contactor has two coils. Both are used for pick-up, and then in approximately 75 milliseconds, one coil is electronically removed from the coil drive circuit. The remaining coil supplies low continuous hold power sufficient for the contactor to meet all of its specified performance specifications. This provides low coil power without PWM electronics that can cause EMI emissions and/or cross-talk on control power.
- 7 Contactor is operated by a coil that changes resistance with temperature. Since pick-up current, coil current and coil power are specified at nominal voltage, they will be lower than indicated at temperatures above 25°C and higher than indicated at temperatures below 25°C. Similarly, pick-up and drop-out voltages will be higher than indicated at temperatures above 25°C and lower than indicated at temperatures below 25°C.
- 8 For pick-up testing of contactors with dual coils, the voltage can not be ramped up slowly, but must be applied instantly to at least the maximum pick-up voltage. Otherwise, the contactor will not pick-up.
- 9 Limit make current to 600A to avoid contact welding. For AC power switching cycles, contact factory.

## APPLICATION NOTES

- Contactors feature internal transorb for coil suppression. **No external diodes** should be added across the coil. The use of additional external coil suppression can slow the release time and invalidate the life cycle ratings, or can cause the contactor not to be able to interrupt the maximum current specified. If lower coil back EMF is required, please contact GIGAVAC for assistance.
- Power switching lifecycles are based on **current flow** from A2(+) to A1(-). For best breaking performance, the contactor should be installed so that current flows from A2(+) to A1(-). There are cases where the contactor will interrupt power in the opposite direction but please contact GIGAVAC to confirm suitability. Direction of current flow is not relevant during make or when flowing on closed contacts. For bi-directional contactors, please contact GIGAVAC.
- Applications with **capacitors** will require a pre-charge circuit.
- Electrical life rating is based on resistive load with 27µH maximum inductance in circuit. Because your application may be different, we suggest you test the contactor in your circuit to verify life is as required.
- End of life is defined as when the dielectric, insulation resistance or contact resistance fails the specifications listed.

## CURRENT SENSE OPERATION

- Operation: Contactor is energized by applying power to Coil+ and Coil-(GND). The current sensing circuit is isolated from the coil and requires power at Sense Vin and Sense Gnd. There are two Sense Vout pins, each with a different 0 amp voltage and range. They both indicate the current through the main contacts (A2 & A1).

Pin 5: 0 to 5V, Sense Vout = I/240 + 2.5

Pin 6: 0 to 10V, Sense Vout = I/120 + 5.0

## SETTINGS PARAMETERS

Parameter	Units	Data
Current Sense Range	A	-600 to +600
Current Sense Accuracy (including temperature)	V	±7%
Sense Vin	V	12-33
Sense Circuit Current (typical)	mA	20

